

SafeLite

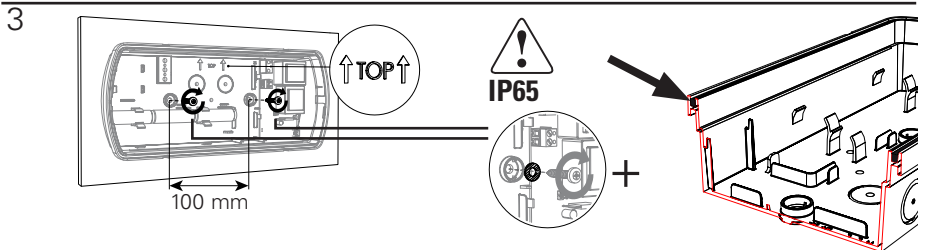

4a.

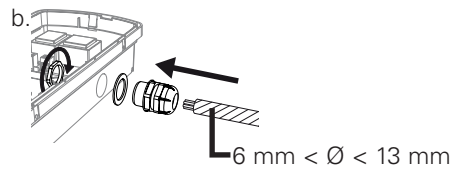
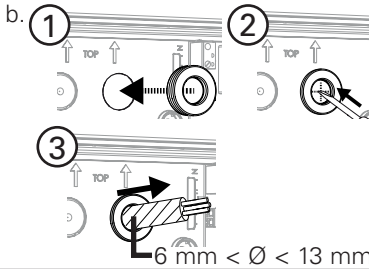
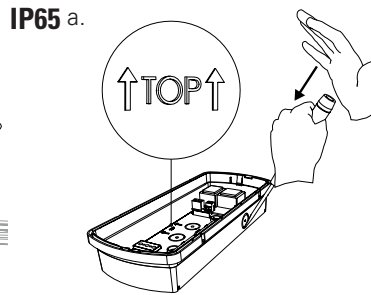
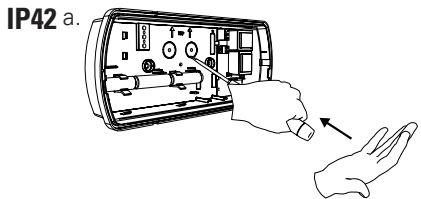
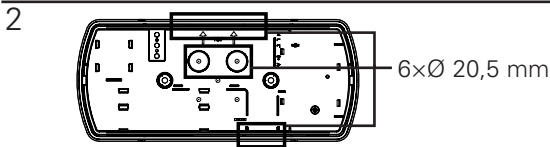
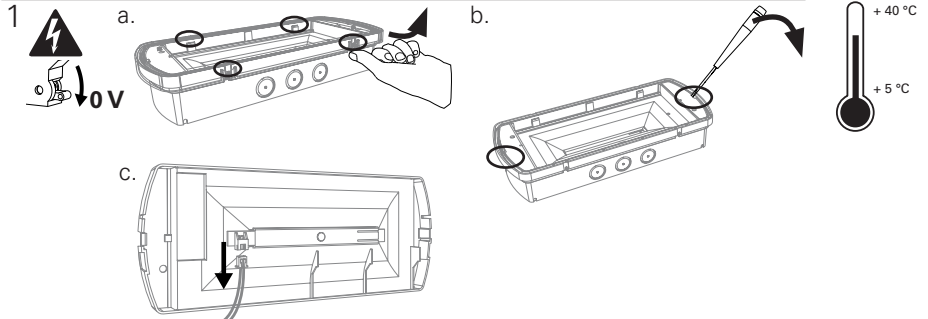
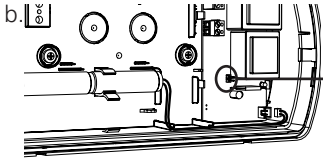
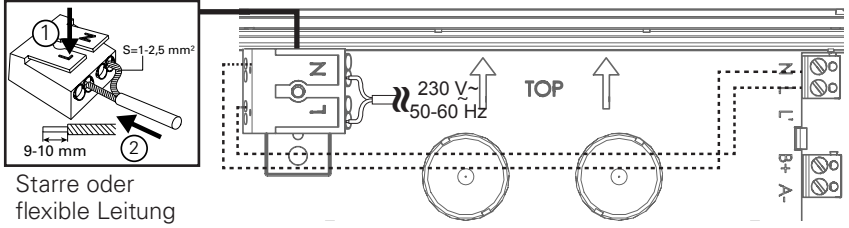

Bereitschaftslicht
Dauerlicht

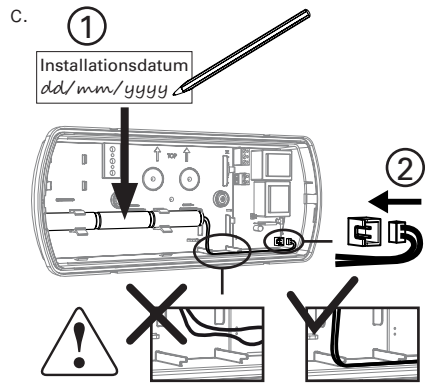

5

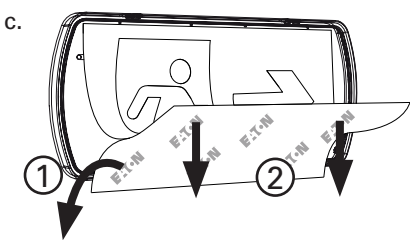
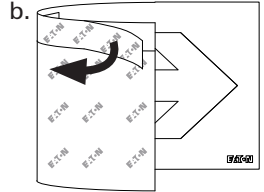
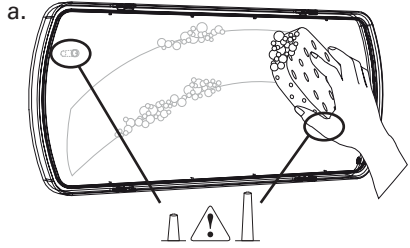
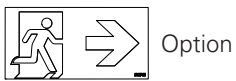

6 a.

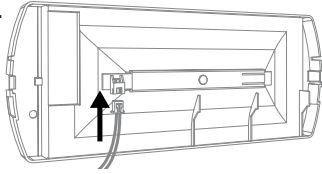

b.

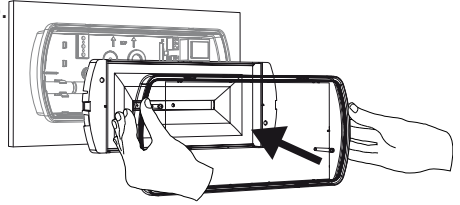

IK07

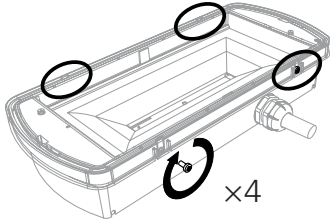

c.

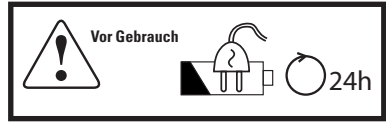

Funktionstest

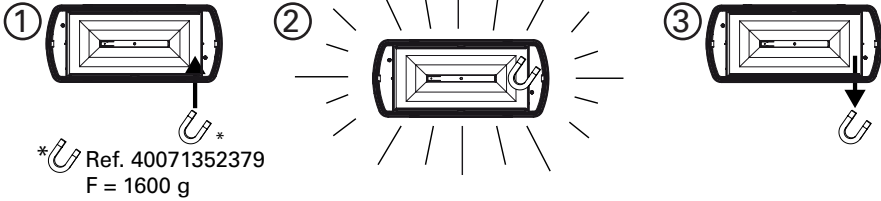

Nicht auswechselbaren

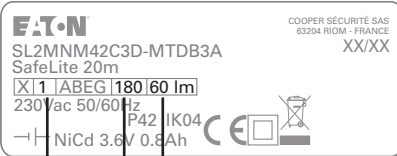
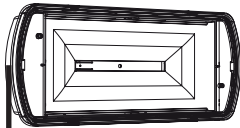

Bereitschaftslicht/
Dauerlicht

Lichtstrom
Nennbetriebsdauer

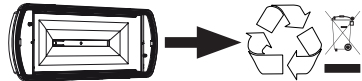

Eaton
EMEA Headquarters
Route de la Longeraie 7
1110 Morges, Switzerland
Eaton.eu

ZNO2037100 A - 10/2016

© 2016 Eaton
All Rights Reserved.

Eaton is a registered trademark.

All trademarks are property
of their respective owners.



EATON

Powering Business Worldwide